

SIGN	DESCRIPTION	DATE	APPROVER

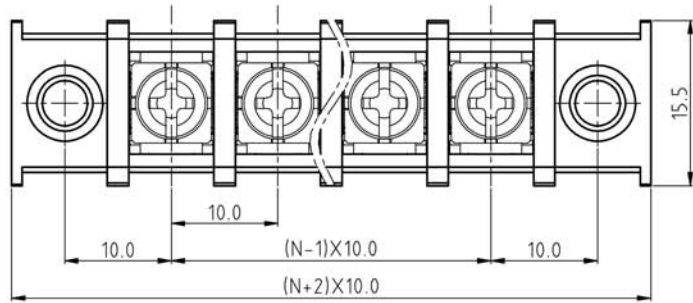

N=Number of contacts

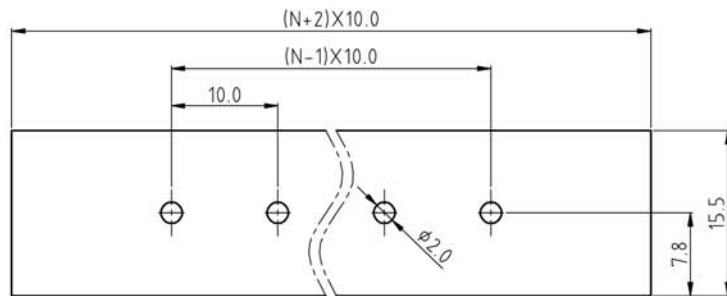
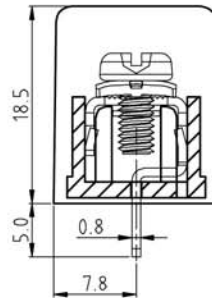
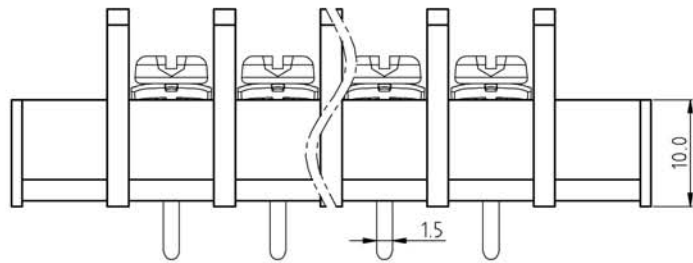

PCB. LAYOUT

Technical Data:

Material:

Contact Pin: Copper Alloy.Tin Plated
Terminal screw: Steel galvanized and with Cr3+ plated
Insulator: Polyamide(Glass filled)(UL94V-0)

Electrical

Voltage rating: 300VAC
Current rating: 25 Amps/way max
Contact resistance: 20mΩ (max)
Withstanding Voltage: 2500VAC(1min) Test time=60sec/1pcs
Wire range: 12-22AWG

Mechanical:

Torque: 10kgf.cm/M3.5
Operating temperature: -40°C to +105°C
Soldering reliability:
Test temperature= 250°C±10°C /5 seconds max

Ordering Information:

U161-1-J-XX- X X X 0

- 2 02 A Black Pa66
- 4 04 B Black Pbt
- 28 28 1 With flange
- 2 Without flange
- 1 "-" Screw Plating Cr3+
- 2 "-/+" Screw Plating Cr3+
- 3 "-" Screw Plating Ni
- 4 "-/+" Screw Plating Ni

WELINK 上海拓尔普电子科技有限公司
Welink International Co.,LTD.

TOLERANCE	APPROVED:	NAME:
X ±0.50	CHECKED:	U161-1 Pitch 10.0mm
X.X ±0.30	DRAWN: Yang Ming 2011,07,02	-Series With flange
X.XX ±0.20	UNITS: mm	REV: A
X° ±1°	SCALE: 2 / 1	PAGE: 1 / 1
		PART NO: U161JXX21X0
		DWG NO: 9U1611001A